

JVALE
Improve Your Retail

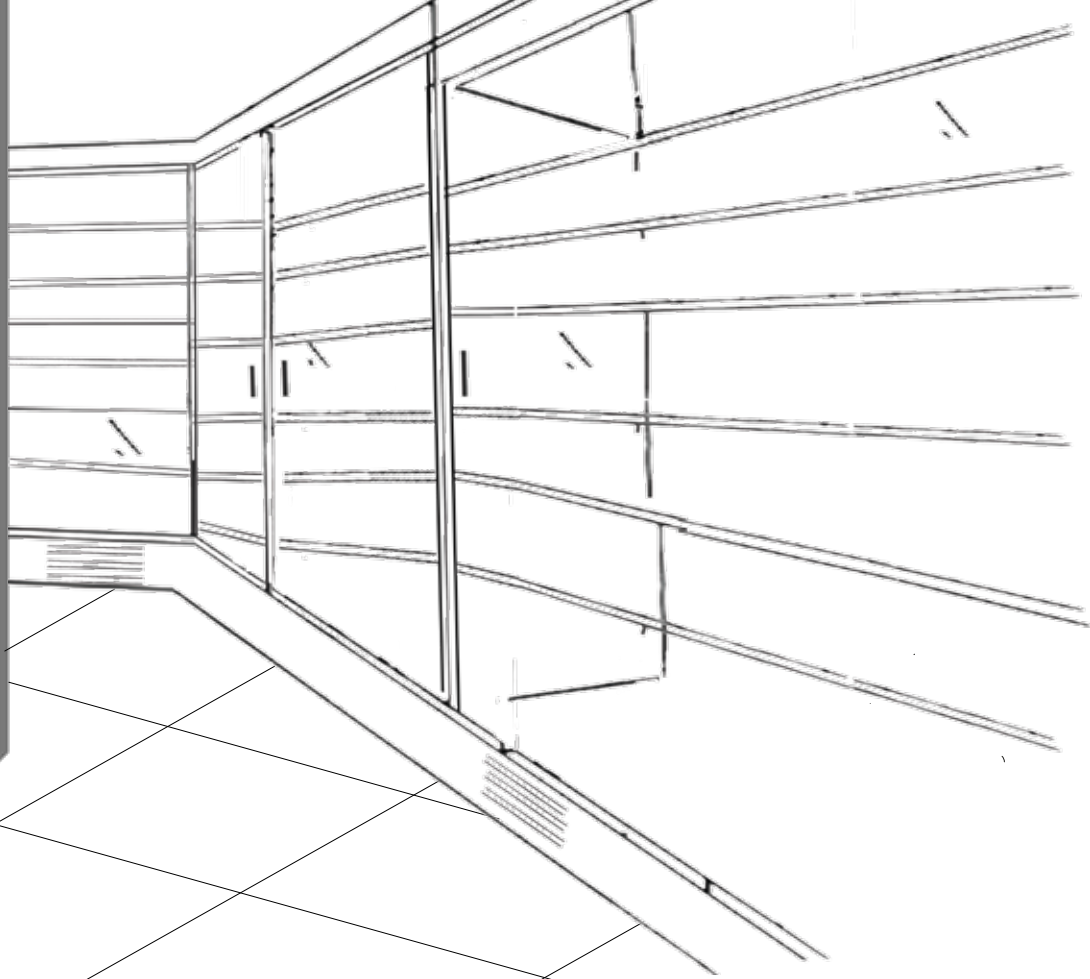

COMMERCIAL REFRIGERATORS

Powered by : ASG



JVALE factory specializes in comprehensive solutions for supermarkets, offering high-quality display refrigerators, shelving solutions, and both metal and wooden decorative works. With 18 years of experience, we began our production in an area of 18,000 m² , and we continue to expand and grow annually.

We used the latest global production solutions to ensure the highest quality of our products. Our commitment to excellence allows us to meet the diverse needs of our clients and provide innovative solutions that enhance the shopping experience.

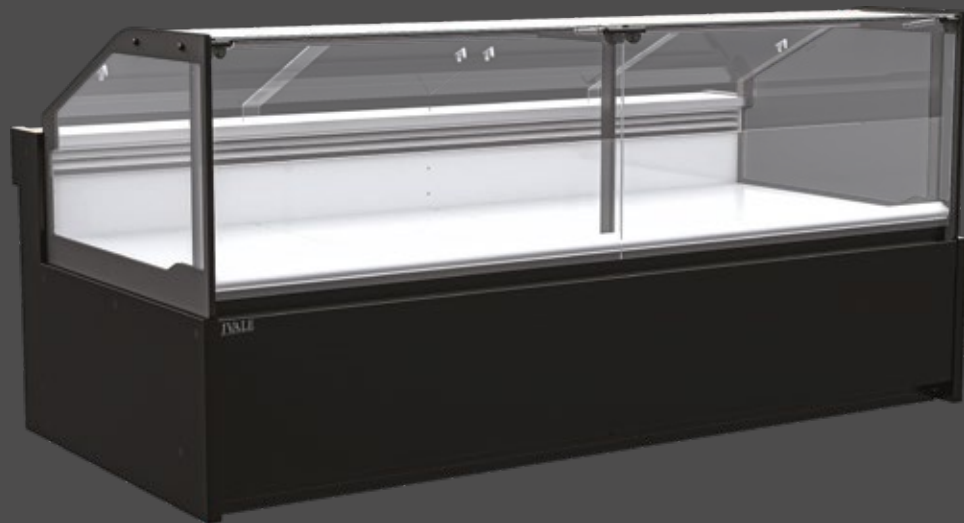

SIWA

flat glass

(PLUG-IN / REMOTE)

SERVE - OVER CABINET

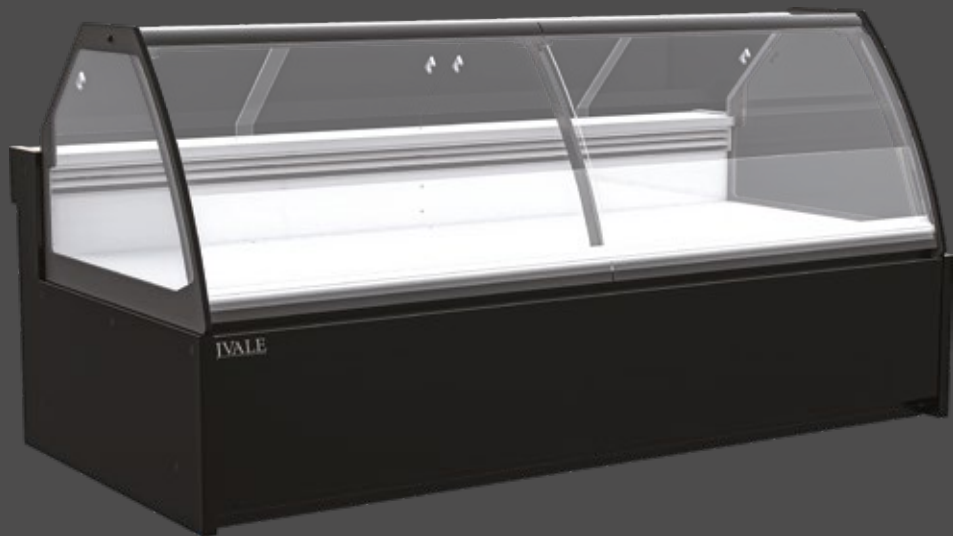

SIWA

curved glass

(PLUG-IN / REMOTE)

SERVE - OVER CABINET



SIWA

self serve

(PLUG-IN / REMOTE)

SELF - SERVE CABINET



SIWA

flat glass - fish
(PLUG-IN / REMOTE)

SERVE - OVER CABINET



SIWA
flat glass bain-marie

SERVE - OVER CABINET

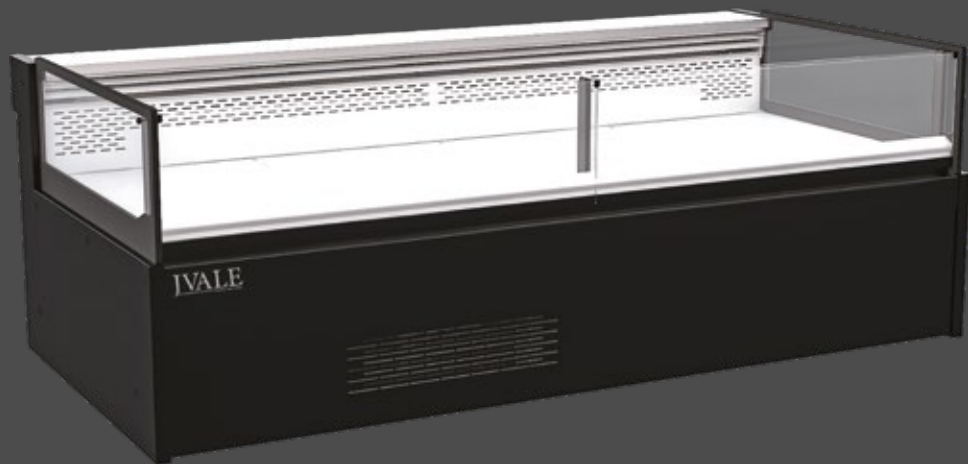

SIWA

flat short glass
(PLUG-IN / REMOTE)

SELF - SERVE CABINET

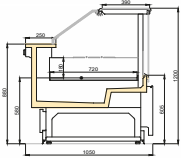

SIWA 700 FG

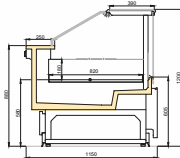

SIWA 800 FG

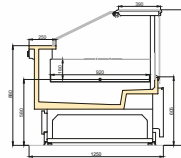

SIWA 900 FG

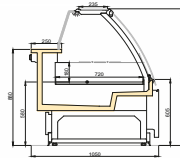

SIWA 700 CG

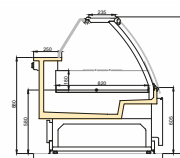

SIWA 800 CG

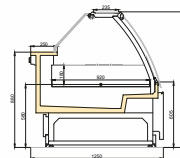

SIWA 900 CG

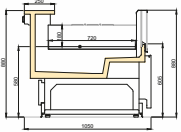

SIWA 700 FSG

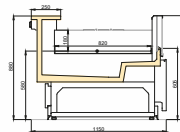

SIWA 800 FSG

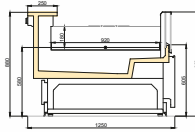

SIWA 900 FSG

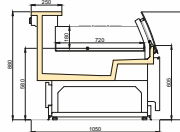

SIWA 700 CSG

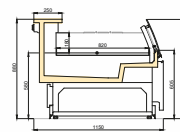

SIWA 800 CSG

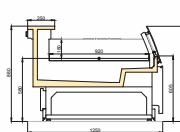

SIWA 900 CSG

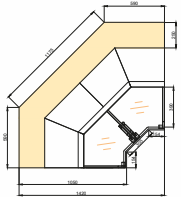

SIWA 700 FG/CG (IC 90°)

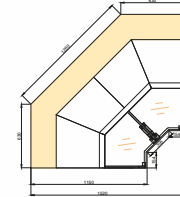

SIWA 800 FG/CG (IC 90°)

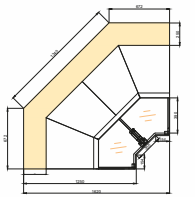

SIWA 900 FG/CG (IC 90°)

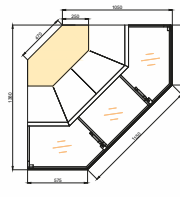

SIWA 700 FG/CG (EC 90°)

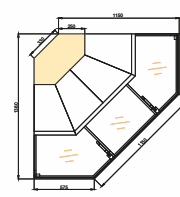

SIWA 800 FG/CG (EC 90°)

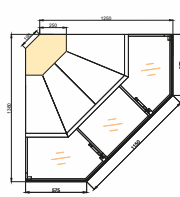

SIWA 900 FG/CG (EC 90°)

SIZE(without sides)
937-1250 - 1875 - 2500 - 2812 -3125 - 3750 mm
interior corner - exterior corner
TEMPERATURE
from 0°c to 5°c

INSTALLED
High efficiency LED Lighting
Digital Controller
Defrost Heaters
Antimist Fans

ORIGIN
EGYPT
FACTORY
JVALE

SIWA IC - EC - FG/SS - CG/SS - IC/NV - EC/NV (PLUG-IN/REMOTE)
SERVE-OVER CABINET

JVALE

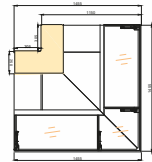

SIWA 800 CG/FG
(EC 90°) SHARP

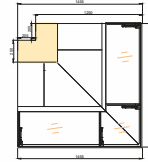

SIWA 900 CG/FG
(EC 90°) SHARP

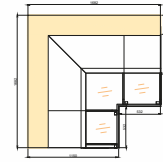

SIWA 800 CG/FG
(IC 90°) SHARP

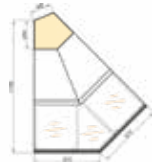

SIWA 800 FG (EC 45°)



SIWA 800 FG (IC 45°)

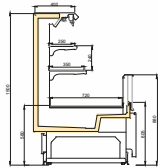

SIWA SS 700 /H1500

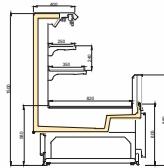

SIWA SS 800 /H1500

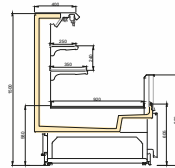

SIWA SS 900 /H1500

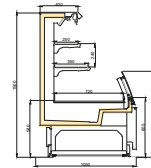

SIWA CG-SS 700 /H1500

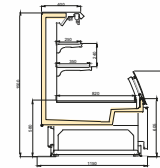

SIWA CG-SS 800 /H1500

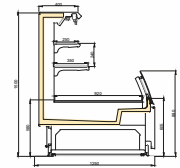

SIWA CG-SS 900 /H1500

SIZE(without sides)
1250 mm
interior corner - exterior corner
TEMPERATURE
from 0°c to 5°c

INSTALLED
High efficiency LED Lighting
Digital Controller
Defrost Heaters
Antimist Fans

ORIGIN
EGYPT
FACTORY
JVALE

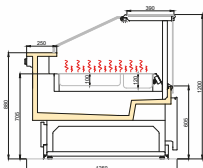

SIWA BM/FG 900

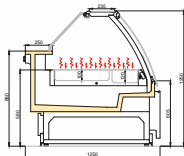

SIWA BM/CG 900

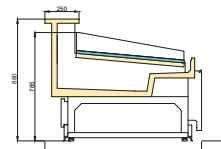

SIWA Fish FG 800

SIZE(without sides)

937-1250 - 1875 - 2500 - 2812 -3125 - 3750 mm

interior corner - exterior corner

TEMPERATURE

from 0°C to 5°C

INSTALLED

High efficiency LED Lighting

Digital Controller

Defrost Heaters

Antimist Fans

ORIGIN

EGYPT

FACTORY

JVALE

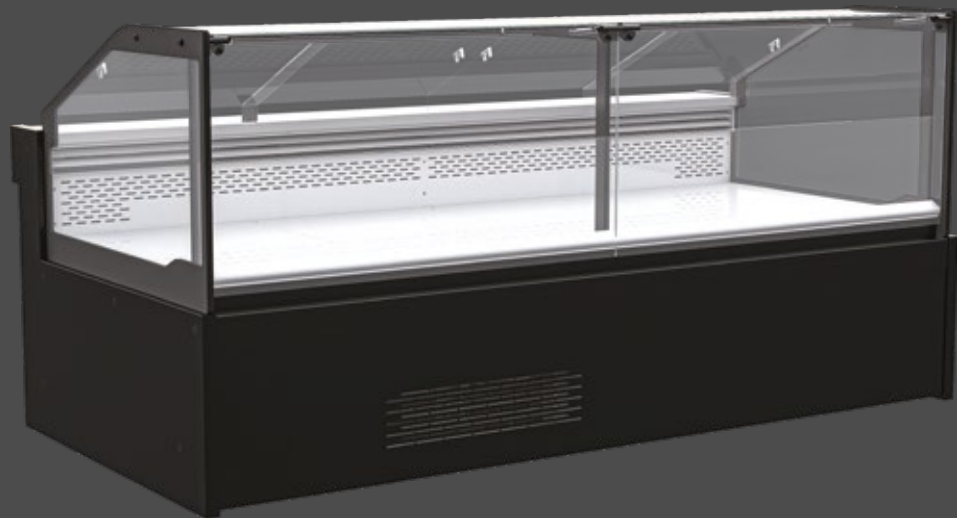

TIBA

flat glass

(PLUG-IN / REMOTE)

SERVE-OVER CABINET WITH STORAGE

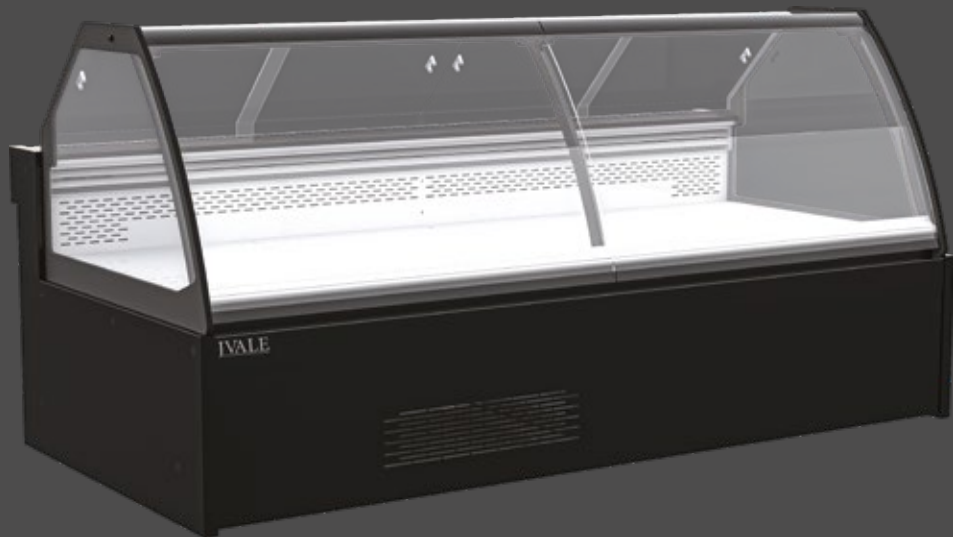

TIBA

curved glass

(PLUG-IN / REMOTE)

SERVE-OVER CABINET WITH STORAGE

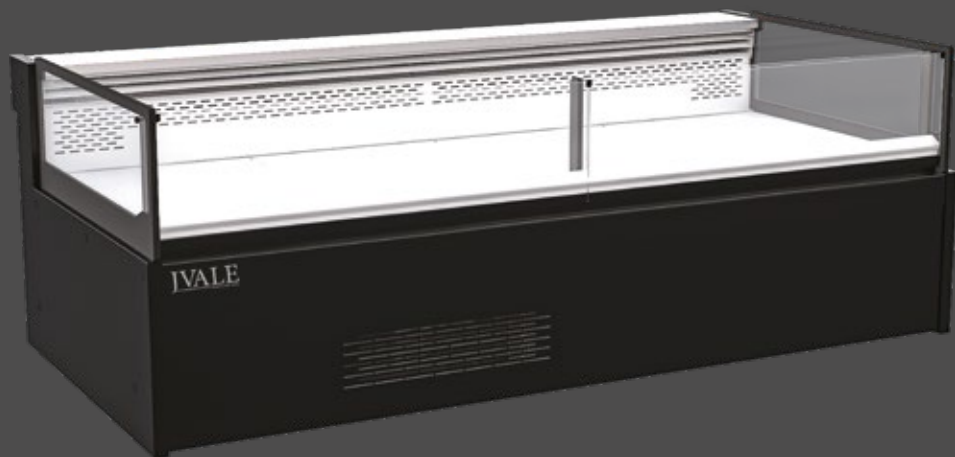

TIBA

flat short glass
(PLUG-IN / REMOTE)

SERVE-SERVE CABINET WITH STORAGE

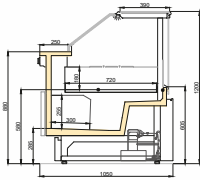

TIBA 700 FG

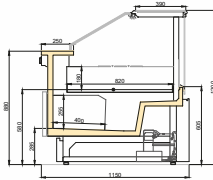

TIBA 800 FG

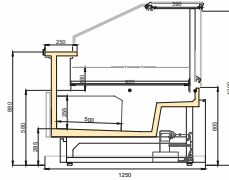

TIBA 900 FG

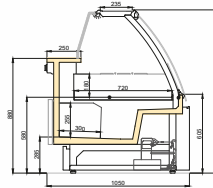

TIBA 700 CG

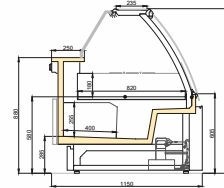

TIBA 800 CG

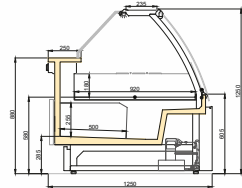

TIBA 900 CG

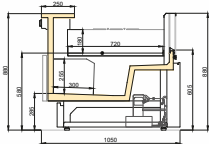

TIBA 700 FSG

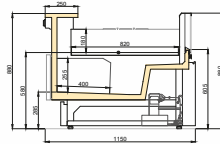

TIBA 800 FSG

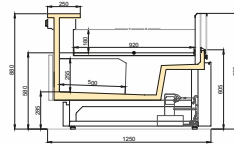

TIBA 900 FSG

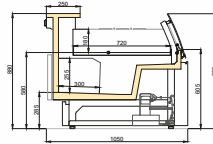

TIBA 700 CSG

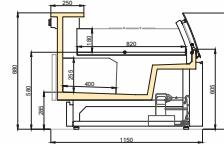

TIBA 800 CSG

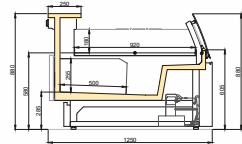

TIBA 900 CSG

SIZE (without sides)

937-1250 - 1875 - 2500 - 2812 - 3125 - 3750 mm

TEMPERATURE

from 0°C to 5°C

INSTALLED

High efficiency LED Lighting

Digital Controller

Defrost Heaters

high efficiency fans - antimist fans

ORIGIN

EGYPT

FACTORY

JVALE



AVALI
night blind
REMOTE

MULTI-DECK COOLING CABINET



AVALI

hinged / sliding doors
(REMOTE)

MULTI-DECK COOLING CABINET



AVALI

hinged / sliding doors
frameless
(REMOTE)

MULTI-DECK COOLING CABINET

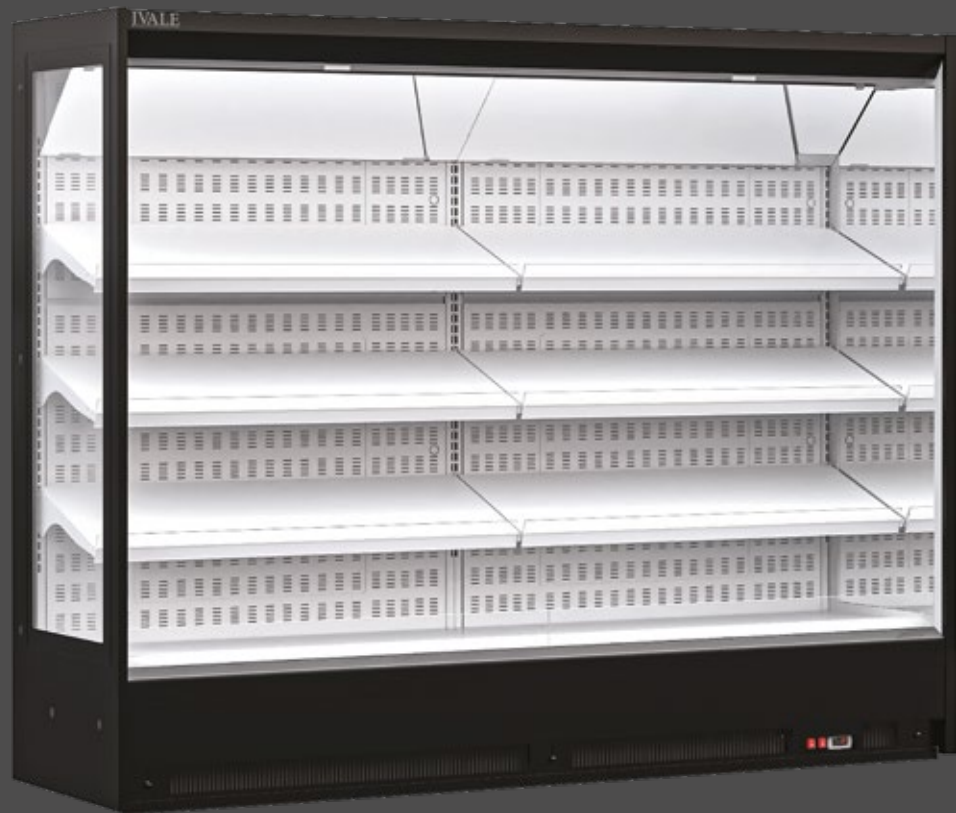

AVALI

fruits & vegetables
night blind
(REMOTE)

MULTI-DECK COOLING CABINET

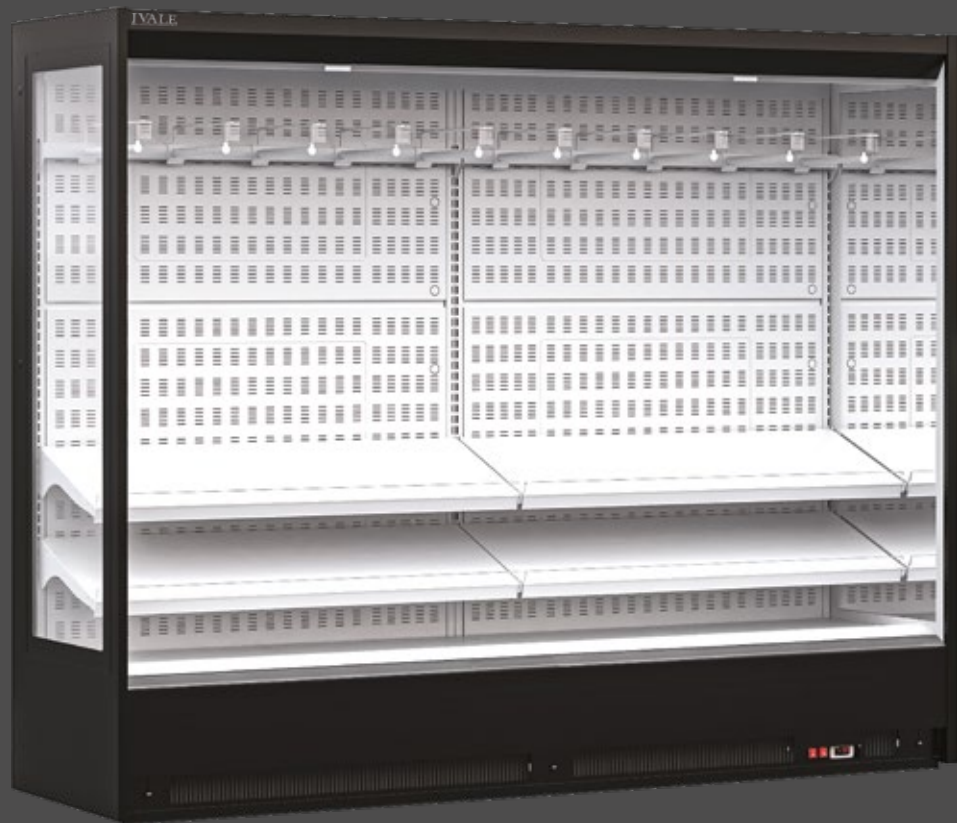

AVALI

meat - night blind
REMOTE

MULTI-DECK COOLING CABINET

AVALI NB/HD/SD/HD-FL/SD-FL (REMOTE) MULTI-DECK COOLING CABINET

JVALE

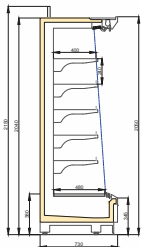

AVALI NB
750/H2050

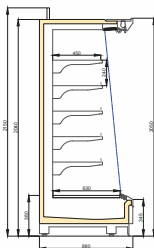

AVALI NB
900/H2050

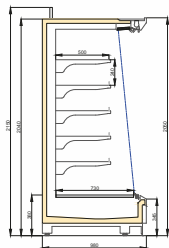

AVALI NB
1000/H2050

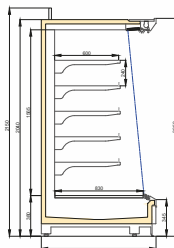

AVALI NB
1100/H2050

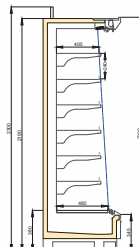

AVALI NB
750/H2200

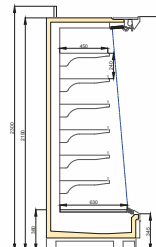

AVALI NB
900/H2200

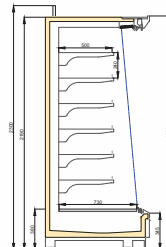

AVALI NB
1000/H2200

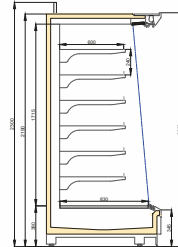

AVALI NB
1100/H2200

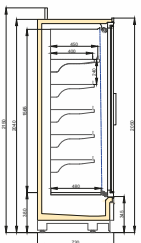

AVALI HD/SD/HD-FL/SD-FL
750/H2050

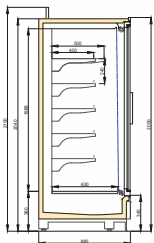

AVALI HD/SD/HD-FL/SD-FL
900/H2050

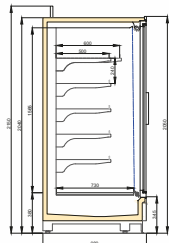

AVALI HD/SD/HD-FL/SD-FL
1000/H2050

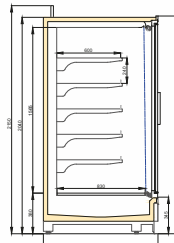

AVALI HD/SD/HD-FL/SD-FL
1100/H2050

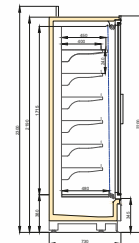

AVALI HD/SD/HD-FL/SD-FL
750/H2200

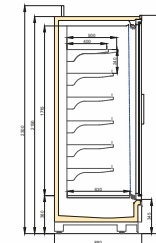

AVALI HD/SD/HD-FL/SD-FL
900/H2200

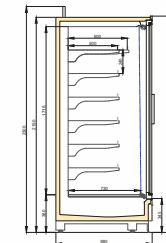

AVALI HD/SD/HD-FL/SD-FL
1000/H2200

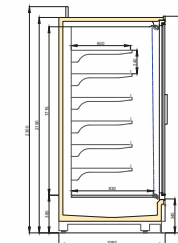

AVALI HD/SD/HD-FL/SD-FL
1100/H2200

SIZE(without sides)

937-1250 - 1875 - 2500 - 2812 -3125 - 3750 mm

TEMPERATURE

from 0°C to 5°C

INSTALLED

High efficiency LED Lighting

Digital Controller

Frame Heaters

ORIGIN

EGYPT

FACTORY

JVALE



ISIS

night blind
flat hinged/sliding doors
(REMOTE)

SEMI-MULTIDECK REMOTE



ISIS

Inclined night blind
Inclined hinged
Inclined sliding doors
(REMOTE)

SEMI-MULTIDECK REMOTE



ISIS

curved sliding doors

(REMOTE)

SEMI-MULTIDECK REMOTE



AMON

night blind
hinged/sliding doors
(PLUG-IN)

MULTIDECK PLUGIN

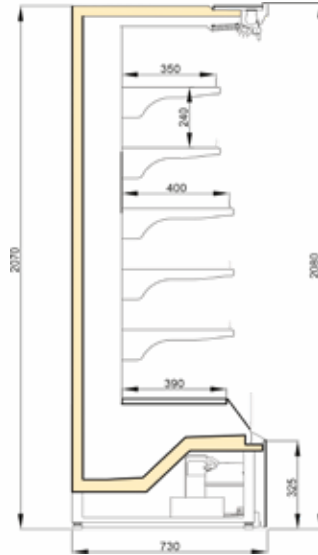

AMON NB 750/H2050

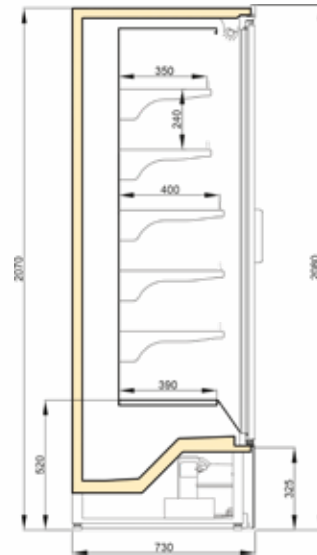

AMON HD/SD 750/H2050

SIZE(without sides)
1250 - 1875 - 2500 mm
TEMPERATURE
from 0°C to 5°C

INSTALLED
High efficiency LED Lighting
Digital Controller
high efficiency fans

ORIGIN
EGYPT
FACTORY
JVALE



QUALA

night blind
Incline hinged
sliding doors
(PLUG-IN)

SEMI-MULTIDECK PLUGIN



QUALA

curved sliding doors
(PLUG-IN)

SEMI-MULTIDECK PLUGIN

QUALA INB-FG-IHD-ISD (PLUGIN) SEMI- MULTIDECK CABINET

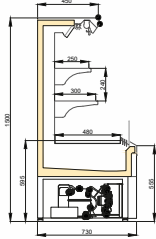

QVALA INB 750/H1500

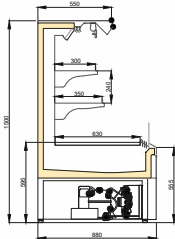

QVALA INB 900/H1500

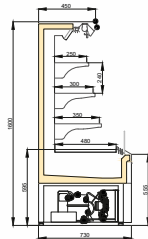

QVALA INB 750/H1600

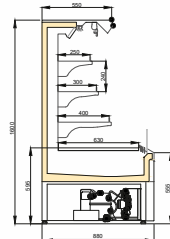

QVALA INB 900/H1600



QVALA IHD 750/H1500



QVALA IHD 900/H1500

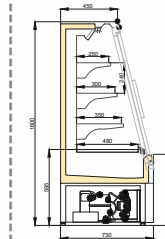

QVALA IHD 750/H1600



QVALA IHD 900/H1600

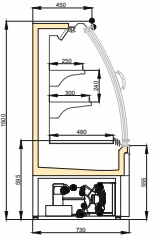

QVALA CSD 750/H1500

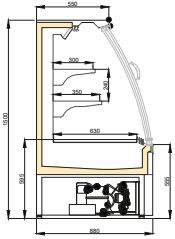

QVALA CSD 900/H1500

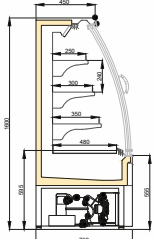

QVALA CSD 750/H1600

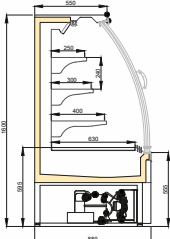

QVALA CSD 900/H1600



QVALA CSD 750/H1500



QVALA CSD 900/H1500

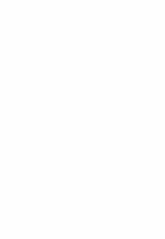

QVALA CSD 750/H1600



QVALA CSD 900/H1600

SIZE(without sides)

937-1250 - 1562 - 1875 - 2500 mm

TEMPERATURE

from 0°C to 5°C

INSTALLED

High efficiency LED Lighting

high efficiency fans

Digital Controller

ORIGIN

EGYPT

FACTORY

JVALE



SAQQARA

hinged doors
(REMOTE)

VERTICAL FREEZER REMOTE

SAQQARA HD (REMOTE) VERTICALFREEZER REMOTE

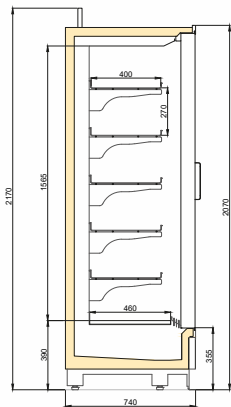

SAQQARA HD 750/H2050

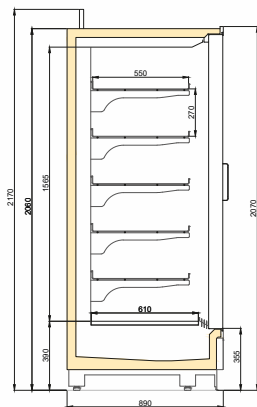

SAQQARA HD 900/H2050

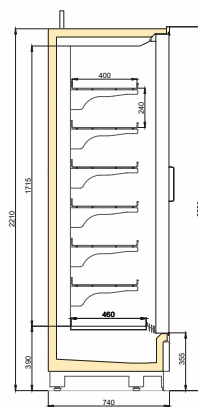

SAQQARA HD 750/H2200

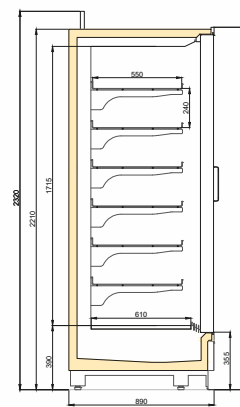

SAQQARA HD 900/H2200

DORS

2 - 3 - 4 - 5

TEMPERATURE

from -15°C to -18°C

INSTALLED

High efficiency LED Lighting

Digital Controller

Defrost Heaters

Frame Heaters

ORIGIN

EGYPT

FACTORY

JVALE



BUTO

hinged doors
(REMOTE)

SEM-VERTICAL FREEZER REMOTE

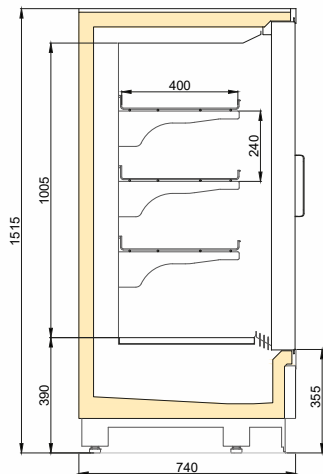

BUTO HD 750/H1500

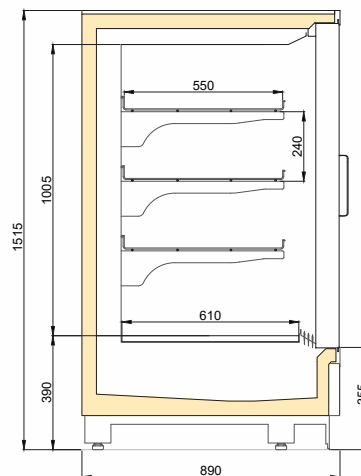

BUTO HD 900/H1500

DOORS

2 - 3 - 4 - 5

TEMPERATURE

from -15°C to -18°C

INSTALLED

High efficiency LED Lighting

Digital Controller

Frame Heaters

ORIGIN

EGYPT

FACTORY

JVALE



BREEZ

hinged doors
(**PLUG-IN**)

VERTICAL FREEZER PLUG-IN

BREEZ HD (PLUGIN)

VERTICAL FREEZER PLUGIN

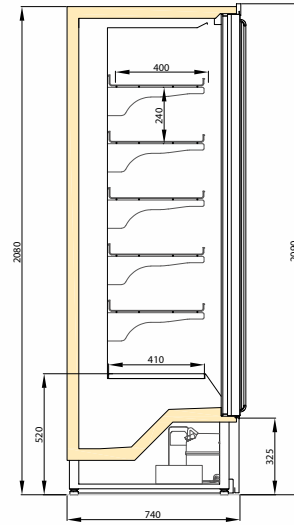

BREEZ HD 750/H2050

DOORS

2 - 3 - 4

TEMPERATURE

from -15 °c to -18 °c

INSTALLED

High efficiency LED Lighting

High efficiency fans

Digital Controller

ORIGIN

EGYPT

FACTORY

JVALE

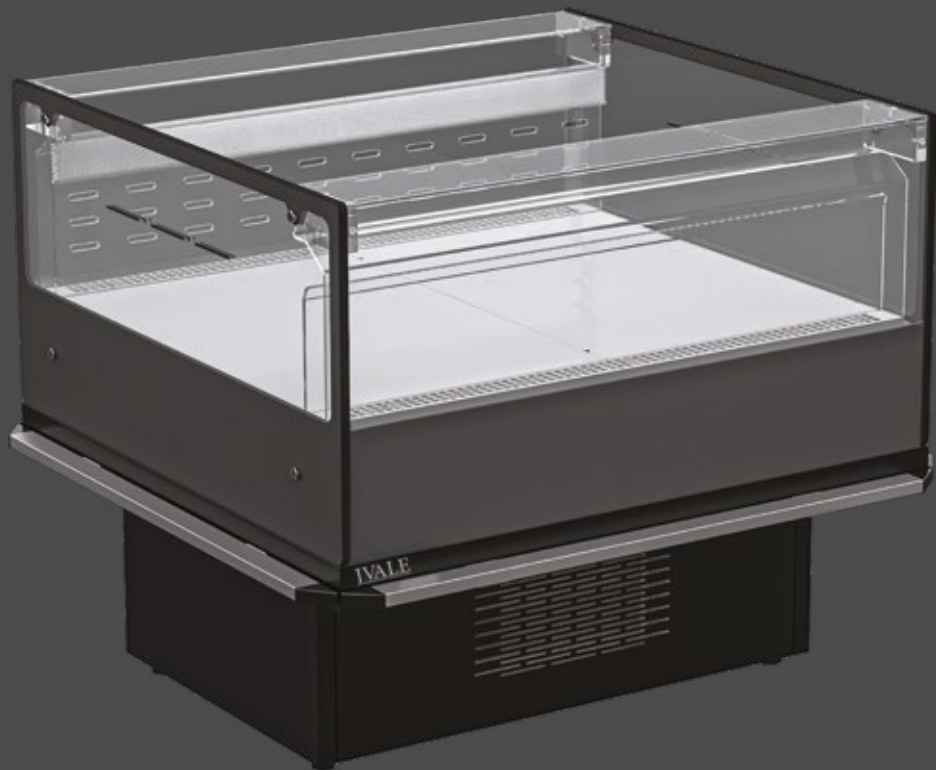

MEMPH

flat open / sliding doors

(PLUG-IN)

PROMOTION PLUGIN

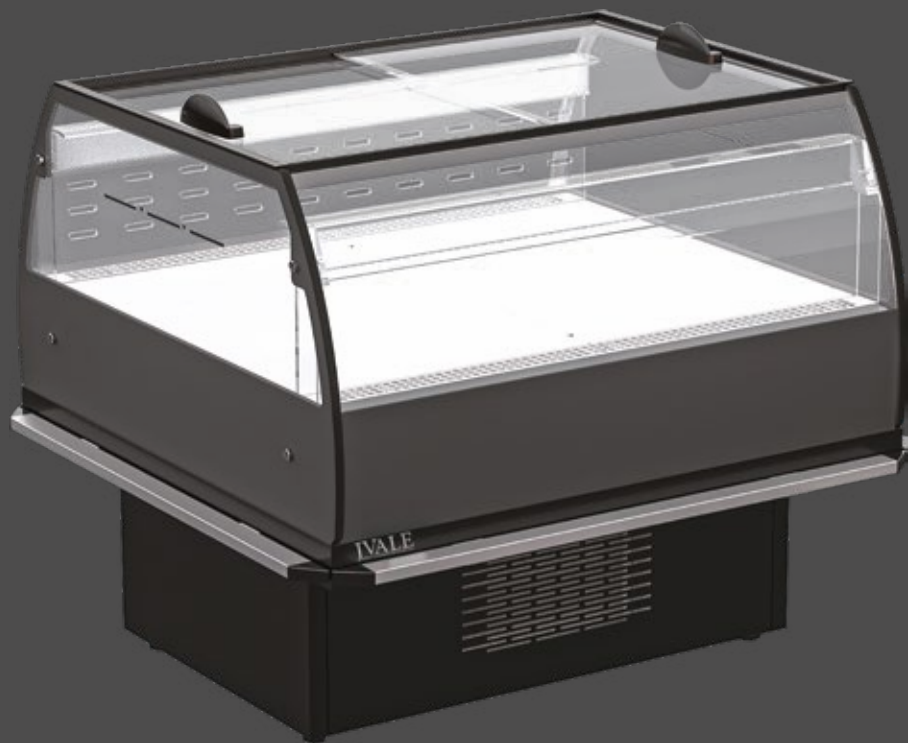

MEMPH

curved open
sliding doors
(PLUG-IN)

PROMOTION PLUGIN

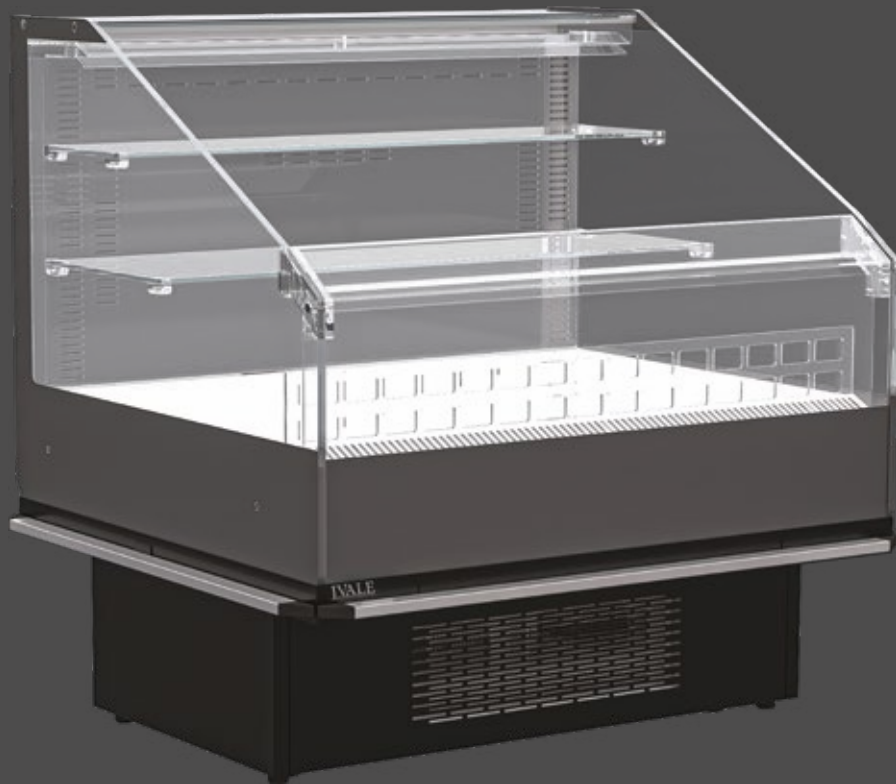

MEMPH

inclined night blind
(PLUG-IN)

PROMOTION PLUGIN

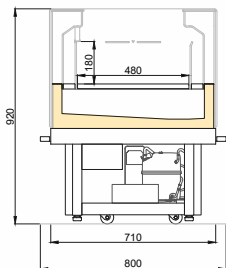

MEMPH OPEN/FG 800

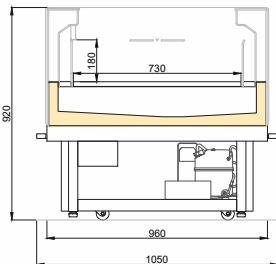

MEMPH OPEN/FG 1000

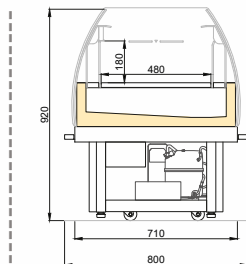

MEMPH OPEN/CG 800

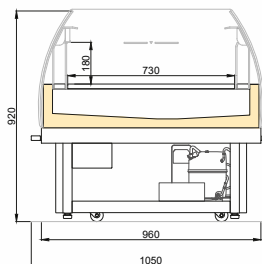

MEMPH OPEN/CG 1000

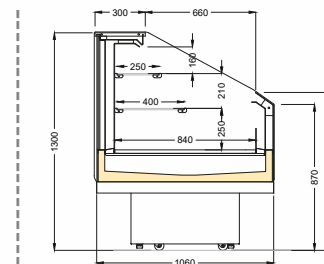

MEMPH OPEN/IF 1000

SIZE
1050-1250 mm
TEMPERATURE
from 0°C to 5°C

INSTALED
High efficiency LED Lighting
high efficiency fans
Digital Controller

ORIGIN
EGYPT
FACTORY
JVALE



SABA

flat glass
(PLUG-IN)

PASTRY PLUGIN

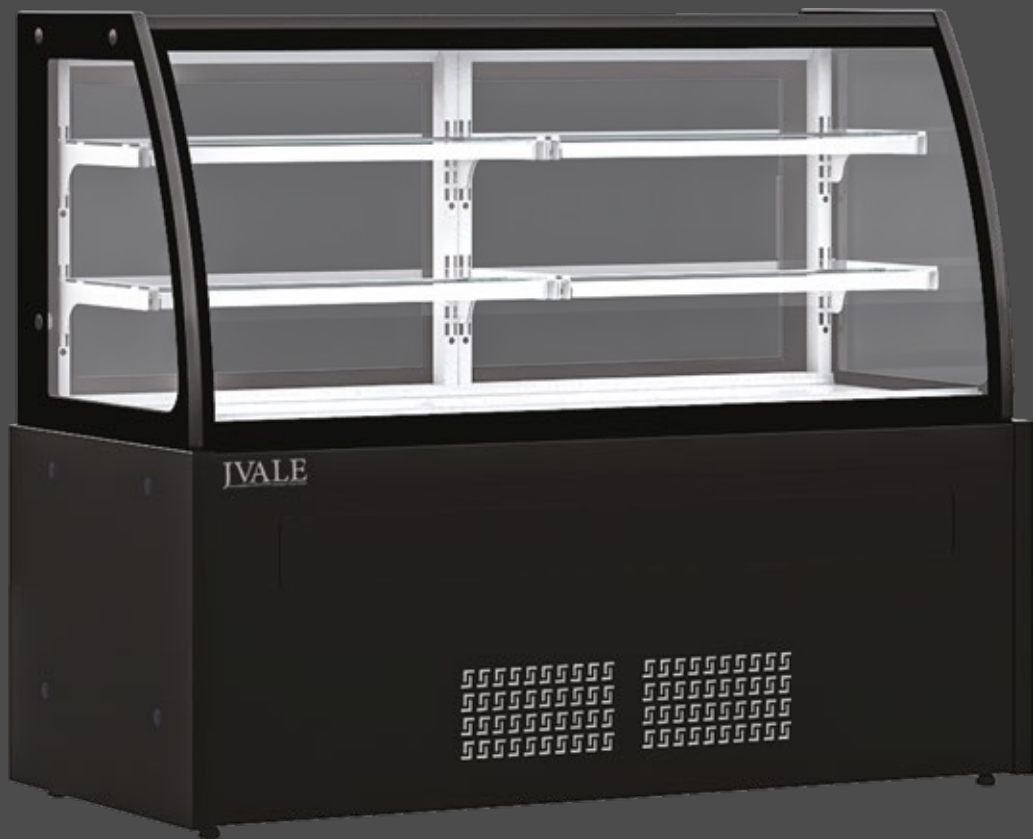

SABA

curved glass
(PLUG-IN)

PASTRY PLUGIN

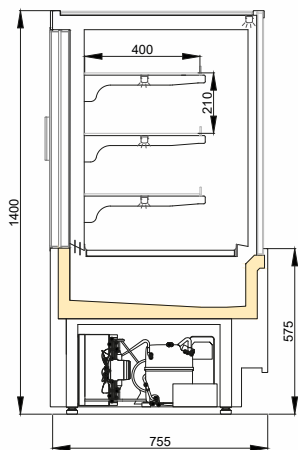

SABA FG/SD 750/H1400

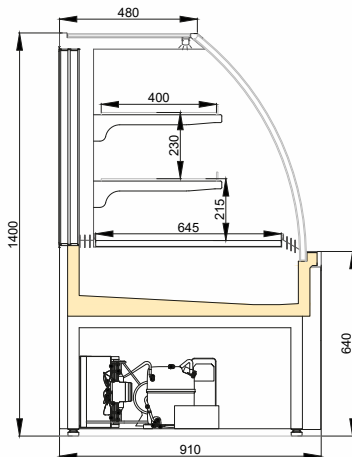

SABA FG/SD 900/H1360

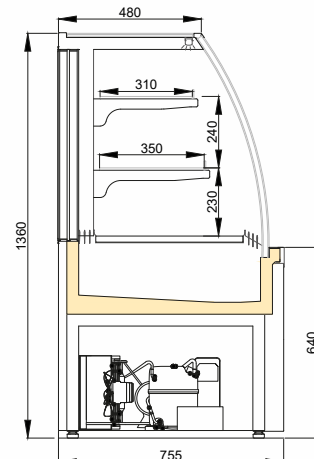

SABA CG/SD 750/H1360

SIZE

937-1250 - 1875 - 2500 mm - Head

TEMPERATURE

from 0°C to 5°C

INSTALLED

High efficiency LED Lighting

high efficiency fans

Digital Controller

ORIGIN

EGYPT

FACTORY

JVALE



EGYPTIAN MADE BY EGYPTIAN HANDS

Powered by : ASG
WWW.AS-GRP.COM

THANK YOU FOR CHOOSING JVALE

 002-01025551580  www.jvale.com  info@jvale.com

AL-BUHAIRA , ABU EL-MATMIR CENTER , 59 th KILOMETER EAST OF THE DESERT ROAD
ALAM AL-MARGAB